

DARAY[®]

Medical



QiLite

LED Dental Light Manual

QAM.QILITE.0915.6



Contents		
1.	GENERAL DESCRIPTION	4
2.	SPECIFICATION	4
2.1	Serial numbers and labelling	4
3.	OPERATION	5
4.	MAINTENANCE, CLEANING AND DISINFECTION	7
4.1	Routine maintenance	7
5.	ADJUSTMENT OF ARM BALANCE TO ELIMINATE DRIFT	9
6.	INSTALLATION	10
6.1	Fitting the Ceiling Plate	11
6.2	Fitting the Downtube	12
6.3	Installation - Wall Mount	16
6.4	Installation - Fitting the joint cover	18
6.5	Installation - Fitting the Lighthead	19
7.	WARRANTY INFORMATION	20
7.1	Returns Policy	20
7.2	Warranty & Returns Information	21

Tel: 0800 878 9864 Fax: 0333 321 0973
info@daray.com • www.daray.com

1. GENERAL DESCRIPTION

DARAY's QILITE has been designed to redefine the traditional, world-renowned BILITE dental operating light. The twin-beam technology used to eliminate shadows in the oral cavity has been updated to replace halogen lamps with economical LED technology, but continues to provide a wide, virtually cold, rectangular light field with extremely sharp edges.

The light head is mounted on DARAY's sophisticated balanced suspension arm, which is light to move and does not drift once positioned. The QILITE features a motion controlled sensor on the underside of the light, which is used to power the light both on and off, and also allows the user to change the light intensity without the need to touch any surfaces, thus reducing the spread of bacteria.

The light assembly comprises of several parts: The mounting, a mains adapter, the arm system and the lighthouse.

2. SPECIFICATION

Light intensity at 0.7m	32,000 lux (Max)
Colour temperature	6,000K
Patch size at 0.7m	80 X 160 mm
Operating voltage	12V AC
Power Usage	15W
Input voltage	230V 50-60Hz, class 1 (earthed)
Arm reach	1650mm
Arm vertical movement	+15° to -45°
Lamp Description	4 LED's
Colour Availability	White

2.1 Serial numbers and labelling

Each QILITE is allocated a unique serial number located on the back of the lighthouse's spigot joint. This is the joint used to connect the lighthouse to its arm system.

The product serial number can also be found in the back of this manual and on the lights arm system itself (location varies slightly depending on mount type).

3. OPERATION

If you have a ceiling mounted QILITE, go straight to step 2.

1. Check that the mains indicator is illuminated on the power supply module.

If the mains indicator does not illuminate, check the mains supply and then the fuses in the module which are located on its right-hand side.

2. Operate the light by passing your hand in front of the sensor. Alternatively you can use the switch located on the top and towards the back of the light-head.

Sensor Control

- Pass hand in front of the sensor (either direction) once to turn the light ON or OFF
- Place hand in front of the sensor and hold to increase or decrease intensity

Switch Control

- Flick the switch once to turn the light ON or OFF
- Push and hold the switch across to increase or decrease intensity

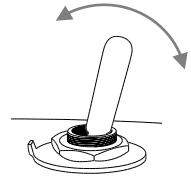

When it reaches its maximum intensity a series of long beeps will sound. To dim the light, replace your hand under the light-head and the intensity will lower. Upon reaching its minimum intensity a series of short beeps will sound.

The infrared proximity sensing switch is located under the light-head. The control range is up to 100mm (4").

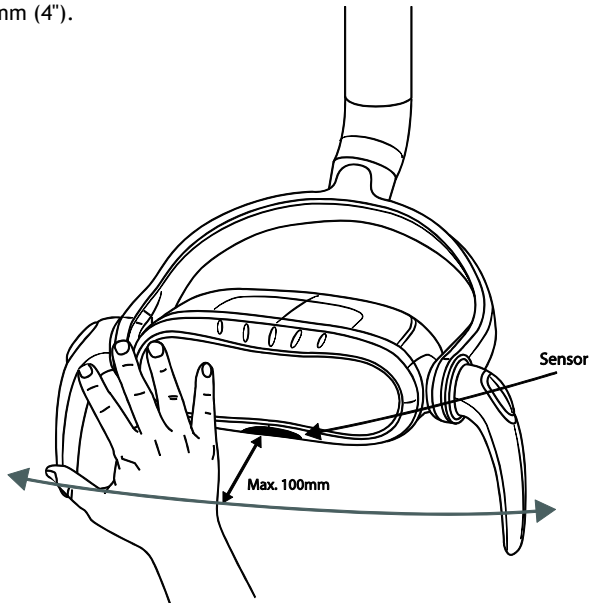

The controller remembers the last intensity setting when turned off and reverts back to this setting when turned on again.

Use the handles to steer the light-patch to where you want it; in the interests of cross-infection control, avoid touching any other part of the light.

The lighthouse comes fitted with a small crescent arm section which allows the head to swivel (pictured below). This leads to a spigot joint that attaches to the suspension arm and has left and right rotation. The joint between the primary arm and Suspension arm allows the light-head to be moved sideways and up / down. The lighthouse itself can rotate 320° on the suspension arm in the horizontal axes, with high vertical movement as well (note: mobile versions do not have a primary arm).

After use, turn off at the lighthouse with the sensor or switch, then also, where applicable turn off the light at the power-supply module on the wall.

The QILITE handles can be removed and replaced in any one of eight different positions to suit the user's individual preference.

To remove the handle, hold the QILITE head in one hand and press the lock button on the handle to release the locking mechanism. Pull the handle away from the head but take care, as it may take some effort to remove the handle.

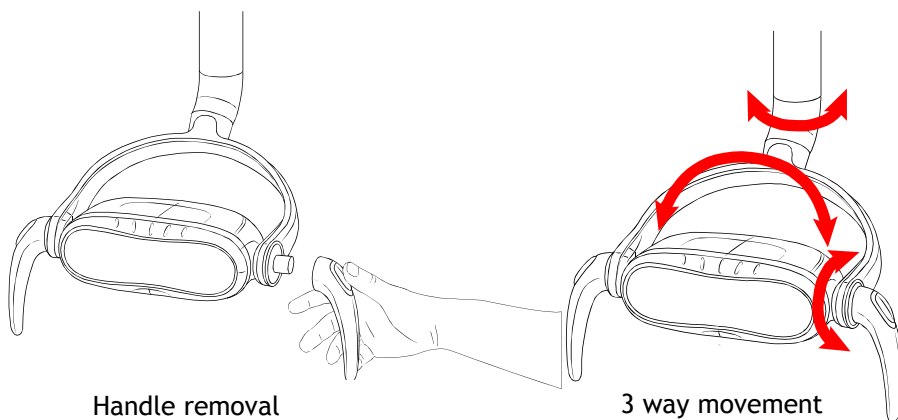

Note: The handles are removable for cleaning but are NOT suitable for autoclaving

Note: Do not force the lighthouse's movement as this could damage the product.

4. MAINTENANCE, CLEANING AND DISINFECTION

WARNING! Do not use strong chemical cleaning agents such as 'Dettol' to sterilise the light.

Do not use any abrasive materials to clean the light.

CAUTION! The light is not waterproof, so do not use excessive cleaning fluid amounts.

Suitably protect hands.

Wipe the light using clean tissue or soft towelling - pay special attention to the motion sensor, light head and handles.

Apply to all surfaces a 1% solution of sodium hypochlorite using a soft cloth.

Within 10 minutes, remove the chemical from all surfaces using a damp, soft cloth. The chemical will cause corrosion of metal parts, if it is not thoroughly removed.

Apply Isopranol to the surfaces - this is an alcohol-based fluid which evaporates without leaving any residue and can be obtained as an impregnated-cloth applicator.

4.1 Routine maintenance

Light-head

Operation	Suggested Interval	Method
Clean all exterior surfaces	As required	Disinfecting and cleaning directions - see section 4.

Arm

Operation	Suggested Interval	Method
Lubricate wall-mount plate bush	Six Monthly	On wall-mounted units, lift the arm so its spigot is almost clear of the bush in the wall-mount plate and re-lubricate if required.
Lubricate ceiling mount spigot	Six Monthly	On ceiling mount units, support the arm and remove the 3 screws retaining the fitting adaptor into the down-tube. Lower the arm until the adaptor and key can be removed. Slide sleeve up and inspect for lubrication. Re-lubricate spigot and sleeve if required. Reassemble.
Check tightness of all five fixing screws.	One month after installation and then annually.	
Check balance of jib over whole range.		See section 6.

Ceiling Mount

Operation	Suggested Interval	Method
Inspect 6 button head socket screws for tightness and check that washers are fitted under head.	Six Monthly	Tighten with appropriate hex key
Check that down-tube is rigidly mounted to the ceiling (do not exert undue force).	Annually	If any movement found - immediately advise your service dealer.

Wall Mount

Operation	Suggested Interval	Method
Check security of wall fixing	Annually	Investigate any movement - ensure your building contractor is consulted if movement is found.

Mobile Mount

Operation	Suggested intervals	Details
Light-head		
Clean all exterior surfaces	As required	Disinfecting and cleaning directions - see above
Arm		
Check tightness of all fixing screws	Annually	
Check balance of jib over whole range	One month after installation and then annually	If unbalanced, follow the procedure, below. If tendency is to fall from fully up, insert key in capstan hole furthest away and with jib fully up move capstan by pulling key towards you. Repeat until no fall at top. Reverse capstan if rise at bottom of jib movement

5. ADJUSTMENT OF ARM BALANCE TO ELIMINATE DRIFT

Insert a small implement (e.g. hex wrench 2mm AF) into one of the holes and turn capstan in the direction of Arrow A until desired balance is obtained.

Note: To eliminate rise in the jib at the fully down position turn the capstan in the opposite direction to Arrow A.

To assist in making this adjustment, it may be necessary to remove the arm joint cover: Remove the 2 snap in plugs and the 2 screws, allowing the cover half mouldings to be separated and the moving cover to slide down the jib arm. This provides better access to the slot through which the capstan nut is adjusted.

Note: When re-assembling, ensure that the moving cover is correctly positioned with the 'T' notation on the component at the 'Top'.

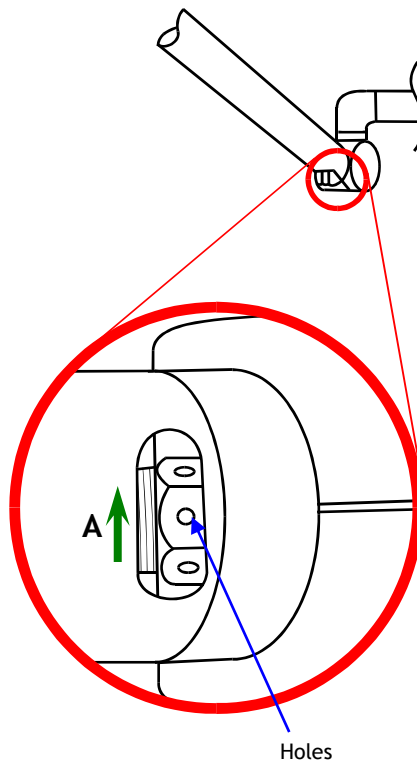

6. INSTALLATION

CAUTION: this product must be earthed.

Ceiling mount

Check you have the following items:

Ceiling-mount plate assembly and cover
Down-tube
Down-tube grub-screw
Down-tube spigot nylon washer
Down-tube bungs
Suspension arm
Light head
Grease sachet
Power supply module

Determine where to mount the light.

WARNING: please note that this information is provided for guidance only and that a qualified builder or structural engineer should be consulted if you have any doubt about the suitability of the proposed mounting position.

WARNING: the light-head operates from a low-voltage supply produced by a transformer in the ceiling mount assembly and fed through the suspension arm. On NO ACCOUNT should the arm be connected directly to a mains voltage.

6.1 Fitting the ceiling plate

Remove the clamp bolts, safety bolt/nylon insert nut and the clamp. Keep these parts in a safe place for use later.

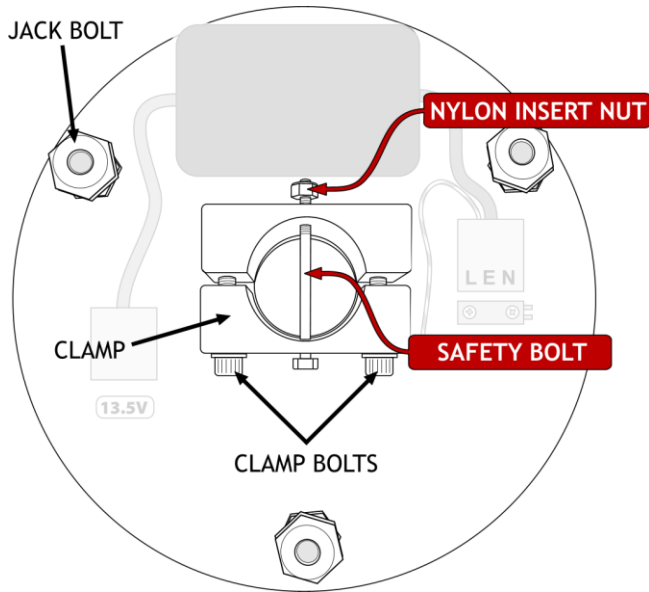

Fix the plate to the ceiling with bolts, screws or studs and nuts through the centre of each jack bolt. Do not fully tighten the fasteners at this point.

Note: The nuts thread-locked to the upper end of the 3 jack bolts act as pressure pads. These pressure pads must be seated firmly against the mounting surface.

The jack bolts can then be used to adjust the position of the ceiling plate and down-tube.

6.2 Fitting the Down-tube

A 1 metre length of down-tube is included with all ceiling mount kits, and must be securely fitted in accordance with these instructions.

The down-tube should be cut to length on-site to suit the particular ceiling height and application.

Note when installed the down-tube must leave clearance above the ceiling mount plate to prevent the cable being trapped.

For determining the cut point, we suggest measuring the distance between the ceiling mounting plate, and a point about 1900mm above the floor.

The length of the down-tube should be altered to suit the room dimensions and the particular application for which the light is to be used.

De-burr as necessary.

NOTE: For suspended ceilings, the ceiling hole trim and retaining band should be placed over the downtube BEFORE proceeding.

Loosely refit the clamp and clamp bolts. Fit the down-tube in the clamp and tighten the clamp bolts to firmly hold it in place. Drill a 6mm hole completely through the tube via the guide holes in the clamp and fit the safety bolt and nylon insert lock nut supplied.

NOTE: TO ENSURE THE USER'S SAFETY, THE SAFETY BOLT AND NYLON INSERT LOCK NUT MUST BE FITTED PROPERLY

Feed the end of the low-voltage cable assembly through the tube.

Tighten both clamp screws fully and evenly until the tube is firmly clamped.

Adjust the 3 large bolts such that the down-tube is absolutely vertical. Tighten the fixing bolts or screws to firmly clamp the jack bolts tight against the joist, tighten the thin locknuts and re-check that the down-tube remains vertical, and the mounting plate has no movement. If necessary, repeat the adjustment.

Run the low-voltage cable to the mounted power-supply module, feed it through the grommet on the top of the module and connect it to the 2-way terminal block wired to the low-voltage output from the transformer.

Refit the module to its mounted rear plate.

NOTE: For suspended ceilings cut a clearance hole in a ceiling tile, replace the tile and slide the trim up the downtube until it is firmly against ceiling tile, then roll the trim retaining band upward until it holds the trim in position.

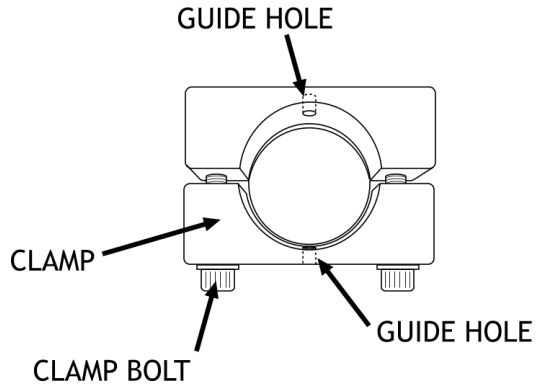

NOTE: For conventional ceilings fit the cover, holding it in place with the retaining band from the fitting kit.

Install the primary arm



To ensure the smooth rotation of the arm, it is essential that the primary arm spigot is **lightly** lubricated before assembly. A sachet of silicon grease is provided.

Place the nylon washer over the primary arm spigot.

Insert the primary arm spigot into the down-tube.

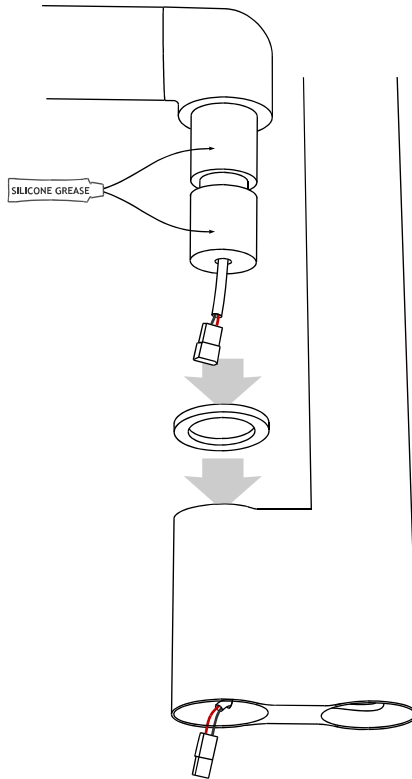

Join the connector from the primary arm to the connector from the down-tube.

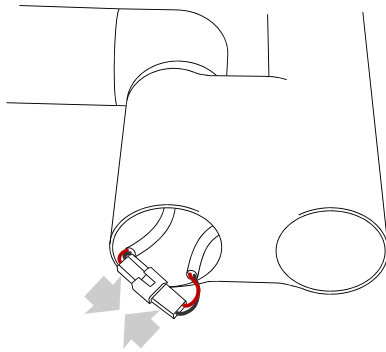

Fit the supplied bungs.

Make sure to sit the joined connectors inside the bung before fitting to prevent the cable from being damaged.

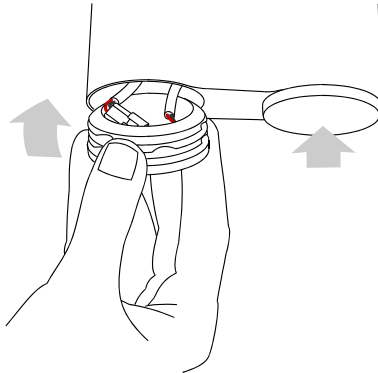

Fit the jib-joint cover (see p.20).

Fit the light-head (see p.21).

Check everything for tightness and safety.

Check the arm and head for freedom of movement.

Rebalance the jib arm if necessary (see p.11).

Wiring the ceiling mounted QILITE

The light should be powered by running a 1.5mm² twin and earth cable to the ceiling plate 230V terminal block via a switched fused spur.

The switched fused spur should be mounted on a wall at a safe and convenient position for the user.

Once installed and fully earthed, provide power to the light to test the power-supply module.

Turn on the light with either the rocker switch on the back of its head or the hand sensor located at the front of the lighthouse under the LED's.

Check the variable intensity by either holding your hand in front of the sensor or by pressing and holding the rocker switch.

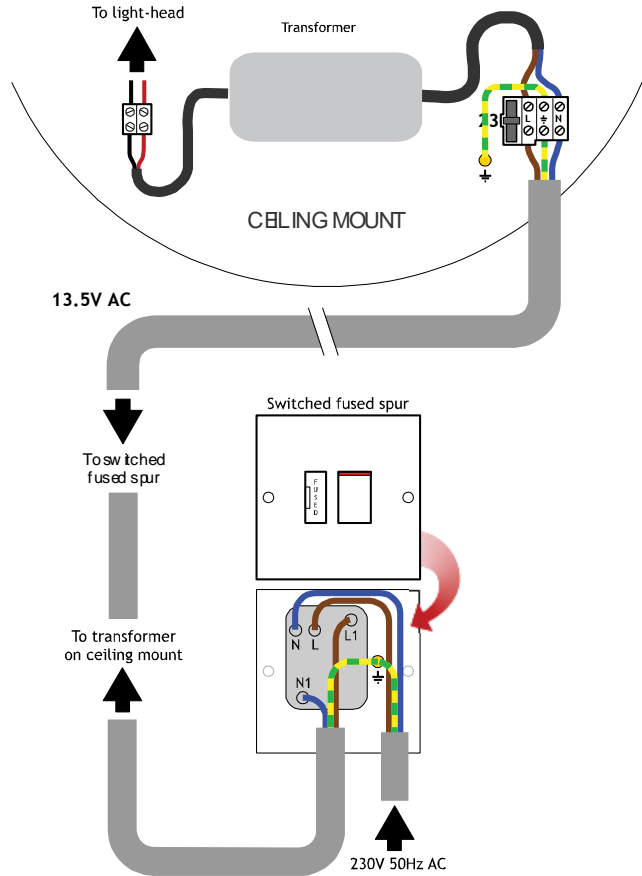

6.3 Installation - Wall Mount

CAUTION: this product must be earthed.

Check you have the following items:

Wall-mount plate
Light-head
Arm System - Primary and Suspension Arm
Power supply module

Determine where to mount the wall bracket. For general medical examination use, we suggest that the bottom of the primary arm mount bracket should be 1900mm from the floor. For other specific applications, mount the wall bracket in a location so that, when fitted, the light-head is at the required height.

WARNING: Consult a building engineer, if in doubt.

Secure the plate to the wall, ensuring that it is truly vertical.

WARNING: the light-head operates from a low-voltage supply produced by a transformer in the power-supply module and fed through the suspension arm. On NO ACCOUNT should the arm be connected directly to mains electricity.

Fit the power-supply module directly under the wall plate.

Remove the rear plate from the power-supply module by slackening the screw in each of the 4 corners.



To ensure the smooth rotation of the arm, **lightly** grease the spigot on the primary arm with the silicone grease provided. Slide the spigot into the bracket on the wall-mount plate, feeding the low-voltage cable from the primary arm through the top of the power-supply module.

Connect the low-voltage cable to the **2-way** terminal block wired to the low-voltage output from the transformer.

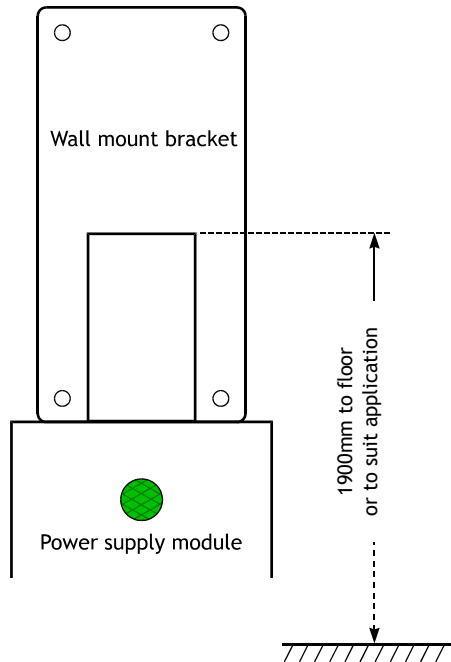

The power-supply module requires an earthed 230V AC electrical supply either fed into it via a switched fused spur.

Connect the incoming mains cable to the **3-way** 'LEN' terminal block in the module.

Fasten the module's earth-bond wire to the rear-plate's earth stud.

Refit the module to its mounted rear plate.

Fit the jib-joint cover (see p.20).

Fit the light-head (see p.21).

Check everything for tightness and safety.

Check the arm and head for freedom of movement.

Rebalance the jib arm, if necessary.

Provide power to the power-supply module and check that the mains indicator illuminates.

Test the light for illumination and that the variable intensity works. To test the on/off function, wave your hand in front of the sensor (under the 4 LED's) or press the switch on the back of the lighthouse.

Test the variable intensity by either holding your hand in front of the sensor or by pressing and holding the switch.

6.4 Installation - Fit the jib-joint cover

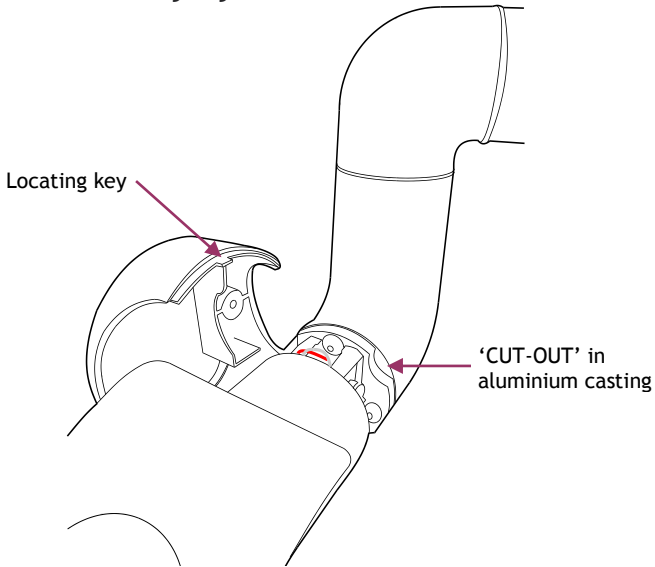

1. Covers are marked 'L' and 'R' on their inside faces as viewed from the end of arm. Engage the slider, with its 'T' mark uppermost, into the groove inside the cover.

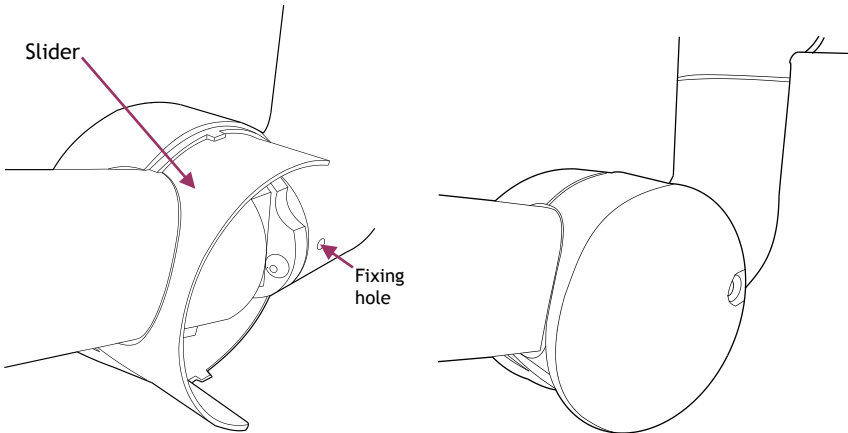

2. Align holes in cover and painted elbow. 'Nip up' the screw to secure.
DO NOT OVERTIGHTEN
3. Fit opposite cover
DO NOT OVERTIGHTEN
Fit a plug in each hole
4. Carefully check the operation of arm and the jib-joint cover.

6.5 Installation - Fitting the light-head

Connect the light-head connector to the connector in the arm

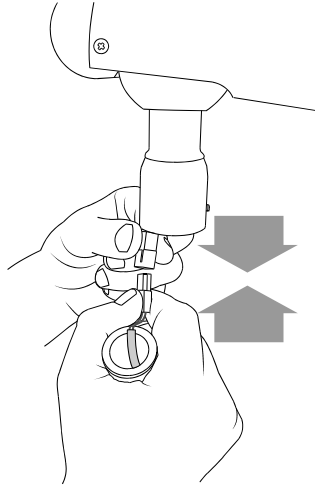

Apply a **little** grease to the light-head spigot and insert it into the arm, being careful not to trap the cable/connector.

Supporting the light-head in one hand, tighten the locking grub-screw with the hex key provided.

NOTE: Make sure the grub-screw is not too tight preventing the light-head from rotating.

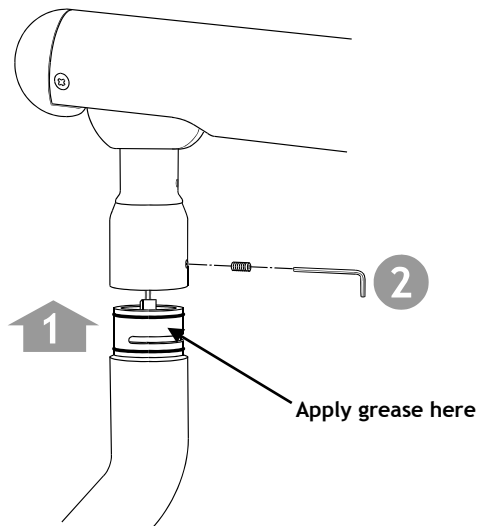



7. WARRANTY INFORMATION

7.1 Returns Policy

IMPORTANT!
 Please fill out your warranty registration online at
www.daray.co.uk/warranty or contact Daray by phone (0800 878 9864)
 or email support@daray.co.uk

DARAY's standard warranty is 12 months. However, this period may be extended for most lighting products from 3 to 5 years* free of charge by completing and submitting the warranty registration.

Year 1:	Warranty includes parts and labour (Return to Base)	*UK only
Year 2-5:	Parts only	

We want you to be completely satisfied with your purchase. If you need to return goods purchased from DARAY Ltd, please read the following information carefully. The DARAY Ltd returns policy provides guidance on when you can return goods we have supplied, and what you can expect from us once you do. To see our detailed returns policy and procedure visit www.daray.co.uk/returns

TYPE OF RETURN	REMEDY
DAMAGED GOODS Goods which are physically damaged on delivery	We must be notified within 24 hours of receipt.
Dead On Arrival (DOA) Goods which do not work	Goods which do not work on arrival or develop a fault within 28 days, we will advance replace the item.
GOODS DEVELOPING A FAULT Goods which have developed a fault within the warranty period.	If the fault develops after 28 days, but within the warranty period, we will initiate the returns procedure.
NON WARRANTY Goods which have developed a fault outside the warranty period.	If a fault develops outside the warranty period, we will initiate the returns procedure charges may be applicable.
OTHER Any situation which is not covered by any of the above.	We will always try to help, but we cannot normally offer a refund.

For additional clarification, please refer to our terms and conditions at www.daray.co.uk/terms. In a small number of cases, we may determine that a replacement would not work any better than the original product we supplied. In such cases we will only offer a refund rather than a replacement for qualifying returns.

Replacement bulbs and spare parts ordered on our website or from supplied part codes are not eligible for credit. We will accept returns and exchange for the correct item.

If your purchase an item incorrectly you can return it within 14 days and it can be exchanged for another product of equal or higher value, excluding transportation charges incurred. Goods and packaging must be returned in their original condition. Under no circumstances will goods be accepted for return if they are damaged, have been subjected to improper handling or abuse or have been used.

If you send us goods that do not qualify for return, you will invalidate your claim to any refund, and you will be obliged to compensate DARAY Ltd for the cost of return postage and any other reasonable costs incurred processing the goods.

Your statutory rights are not affected.

7.2 Warranty Details

TERMS AND CONDITIONS OF WARRANTY

1. To qualify for this warranty you must register on www.daray.co.uk or return to Daray Ltd (Daray) the duly completed warranty-registration form accompanying the product.
2. Daray warrants this product (excluding lamp) against faulty material and workmanship during the period of the warranty. The period of warranty is the period stated on your warranty card and commences on the date of purchase of the product. In the event that the product is not in good working order Daray will provide, during the warranty period, a free repair service within the United Kingdom. The warranty is subject to proof of purchase being provided; therefore, you should retain your original receipt.
 - 2.1 The repair service consists of the provision of spare parts and/or replacement products (at Daray's discretion) which will be provided on an exchange basis and will either be new, equivalent to new or reconditioned. All replaced spare parts and products shall become the property of Daray.
 - 2.2 Daray's only obligation under this warranty is the provision of the service as set out above.
 - 2.3 All products are returned to Daray at the customer's cost and risk. Products to be returned should be adequately packed. For the address to send returns to please visit www.daray.co.uk
3. Daray's arrangements for providing service provided under this warranty may include the use of sub-contractors.
4. This warranty does not cover damage or defects in the Product caused by or resulting from:
 - Wilful neglect or negligence by anyone other than Daray;
 - Improper use, storage or handling of the product;
 - Use of non-Daray approved parts (such as replacement lamps) not compatible with the Product;
 - Fire, accident or disaster;
 - Use of non-Daray modifications other than in accordance with Daray's instructions;Attachment of fittings and accessories not approved by Daray;
Repairs, modifications carried out by service personnel not approved by Daray;
 - Damage caused by chemical corrosion from cleaning agents not approved by Daray.
 - Failure to use or install the product in accordance with the manufacturer's instructions.
5. Nothing in this warranty shall have the effect of restricting or excluding the liability of Daray in respect of:
 - a) Death and personal injury caused by the negligence of Daray, or for fraud;
 - b) Under the *Consumer Protection Act 1987* to a person who has suffered damage caused by a defective product or to a dependant or relative of such a person;
 - c) Direct damage to your property caused by the proven negligence of Daray.
6. This agreement does not give any rights other than those expressly set out above and in particular, Daray will not be responsible for any loss of income, profits or contracts or any direct or indirect consequential loss, damage caused to or suffered by the purchaser as a direct result of this agreement.
7. This warranty is offered (subject to these terms and conditions) in addition to, and does not affect your statutory rights.
8. Daray may disclose your details and other personal information to companies within the Daray group including any subsidiary company or sub-contractor of Daray for the purposes of performing our obligations hereunder.
9. You must not resell outside the UK any products supplied by Daray and covered by the *Export of Goods (Control) Order 1992* (or any law that replaces it) without obtaining all necessary licences. You also agree not to sell the product in the UK if you know or think that the person buying the product intends to export it without getting the necessary licences. You agree to impose similar conditions to these on anyone you sell the product to.
10. These conditions shall in all respect be governed and construed in accordance with English law and the exclusive jurisdiction of the English courts.

Product:

Serial No: